

°M Warmer System

A portable IV-fluid warming system

USER MANUAL

ENGLISH



	Page
1. INTRODUCTION.....	4
2. INDICATION FOR USE	4
3. CLINICAL AND EDUCATIONAL INFORMATION	5
4. GENERAL INFORMATION ABOUT THE °M WARMER SYSTEM	5
5. OVERVIEW OF °M WARMER SYSTEM.....	5-7
6. UNPACKING OF THE °M WARMER SYSTEM.....	7
7. CHARGING OF THE POWER PACK.....	8-9
8. USE OF THE °M WARMER SYSTEM.....	10-18
9. END THE USE OF THE °M WARMER SYSTEM.....	19
10. USER INTERFACE AND ALARMS ON THE °M WARMER SYSTEM.....	20-21
11. MAINTENANCE AND CLEANING	22-23
12. DISPOSAL	23
13. OPERATING TEMPERATURE RANGE	24
14. SAFETY INFORMATION.....	25-26
15. SYSTEM ERROR AND SERVICE.....	27
16. SYMBOLS.....	28-29
17. TECHNICAL SPECIFICATIONS.....	30-32
18. ELECTROMAGNETIC COMPATIBILITY	33-40
19. ORDERING INFORMATION.....	41

1 INTRODUCTION

This user manual provides the user the information needed to successfully implement and operate the °M Warmer System. This guide neither replaces a formal education nor training in the use of intravenous infusion systems, as may be required by local regulations.

- ⚠ Before the °M Warmer System is used, the user manuals for the °M Warmer System and the Charger should be thoroughly read.

2 INDICATION FOR USE

The °M Warmer System is intended to warm blood, blood products and intravenous fluids prior to administration. It is designed to be used by healthcare professionals in pre-hospital, hospital, clinical and other environments to reduce the risk of hypothermia in the patient.

- ⚠ Follow AABB's 'Guidelines for the Use of Blood Warming Devices', which warns against heating when administering platelets, cryoprecipitate, or granulocyte suspensions.
- ⚠ Some medicaments or compositions may be sensitive to heating. As is the case with all systems for heating liquids and blood, the manufacturer's instructions regarding heat sensitivity should be carefully read before use.
- ⚠ The use of inline air and particulate filters is not contraindicated for the °M Warmer, when deemed appropriate by the treating clinician's judgement and in accordance with local clinical guidelines and practices, and with filter manufacturer's instructions for use.
- ⚠ Do not pass medications through the °M Warmer System. If needed, infuse the medications after the °M Warmer.
- ⚠ Do not use °M Warmer with infusions fluids with a pH lower than 3 or higher than 8.

3 CLINICAL EDUCATIONAL INFORMATION

It is assumed that before the °M Warmer System is used, the users are trained to set up and use blood/IV fluids in a medically approved manner that includes aseptic techniques and standard hospital procedures.

The °M Warmer System can, when administered properly, help prevent hypothermia and the complications from hypothermia. The device will also make the patient feel more comfortable during IV infusions.

4 GENERAL INFORMATION ABOUT THE °M WARMER SYSTEM

The °M Warmer System is a portable heating system for intravenous infusion. The °M Warmer System can heat the fluid/blood from 5°C up to 37°C at flow rates up to 150 ml/minute. At low flow rates, the output temperature will be up to 41°C, and at flow rates higher than 150ml/min, the output temperature will be lower than 37°C.

5 OVERVIEW OF °M WARMER SYSTEM

Information regarding the °M Warmer System can be found in:

- The user manual for the °M Warmer System (this manual – included with each Power Pack*)
- The user manual for the Charger (UK version) included with each charger – other languages can be found online at www.mascot.no/downloads/user-manuals/
- The M° Warmer Quick Guide (supplied with each box with 5 pcs °M Warmer devices).

You can order the latest edition of the manual by sending an e-mail to support@mequ.dk and write User Manual in the subject line. Also, please specify which language you want the user manual in. You will then receive user manual in a PDF version. All specifications are subject to change without notice.

** In this manual, the term Power Pack is used to cover both the Power Pack and the Power Pack+ (except when specifically stated).*

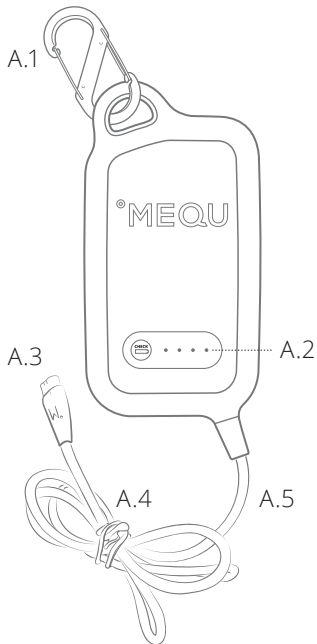

A. POWER PACK

- A.1 Carabiner
- A.2 Battery Indicator
- A.3 Connector
- A.4 Cable strap
- A.5 Cable

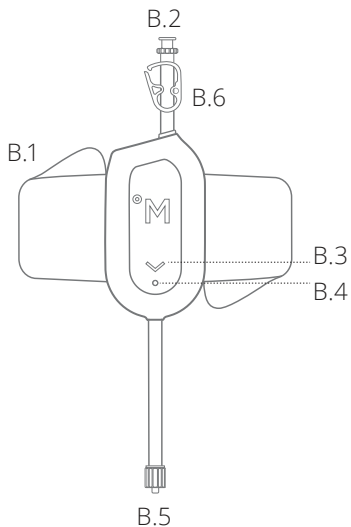

B. °M WARMER

- B.1 Adhesive for fixation
- B.2 Luer to IV-fluid
- B.3 Function indicator arrow
- B.4 Alarm indicator
- B.5 Luer to IV-catheter
- B.6 Pinch Clamp (not mounted on tubing)

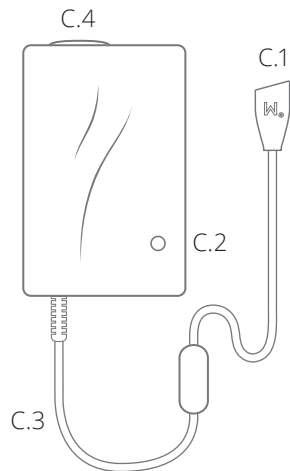

C. CHARGER

- C.1 Connector to Power Pack
- C.2 Charging status
- C.3 Cable
- C.4 Outlet to mains

THE SYSTEM CONSISTS OF 3 UNITS:

- An °M Warmer: One single patient use device with sterile fluid path that heats fluid/blood
- A Power Pack: A rechargeable battery unit that supplies energy to the °M Warmer
- A charger for the Power Pack

The Power Pack and the Charger must only be used with the °M Warmer and not for any other use.

A BOX WITH 5 °M WARMER DEVICES

- 5 °M Warmer single patient use devices with sterile fluid path packed in sealed packages
- 1 Quick Guide for the °M Warmer System

A BOX WITH 1 POWER PACK

- 1 Power Pack with cable connector to the °M Warmer device
- 1 Carabiner
- 1 user manual for the °M Warmer System

A BOX WITH 1 CHARGER

- 1 Charger
- 4 plugs for connecting the Charger to mains (EU, UK, AU and US)
- 1 user manual for the Charger

If all of the above items are not present, please contact your dealer immediately.

All three items (Power Pack, box of 5 °M Warmers and Charger) can also be purchased separately – see 'Ordering Information'

6 UNPACKING OF THE °M WARMER SYSTEM

After receiving the °M Warmer System you must inspect the shipping boxes and their contents for damage that may have occurred during shipment. If any of the contents are visibly or mechanically damaged, or if the order is not complete, please contact your local supplier immediately. You receive the complete °M Warmer System in three boxes:

7 CHARGING OF THE POWER PACK

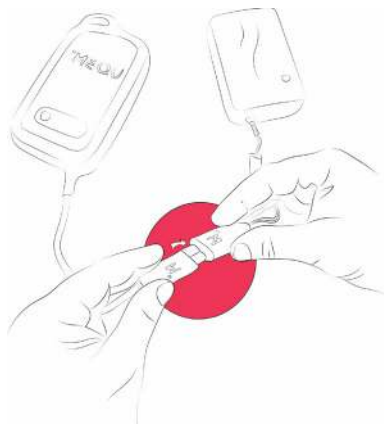

Fully charge the Power Pack upon receipt before it is placed into service or storage. Also, the Power Pack must be fully charged between uses to ensure optimal performance. If the Power Pack is stored for longer period of time, fully charge the Power Pack approximately once a year.

The charging time from discharged battery to full charge is max. 2.5 hours for the Power Pack and max. 3 hours for the Power Pack⁺. Operating temperature range when charging the Power Pack is 10°C - 40°C.

⚠ Only use the designated Charger supplied with the °M Warmer System for charging the Power Pack.

Charging of the Power Pack must take place outside the patient area (i.e. minimum distance from the patient of 1.5m).

THE POWER PACK IS CHARGED AS FOLLOWS:

- Attach the correct AC plug corresponding to your AC mains outlet to the Charger (this only needs to be done the first time - see separate Charger manual)
- Connect the Charger to the wall outlet (100-240VAC). Connect the Power Pack to the Charger
- The Power Pack is fully charged and ready for use when all 4 LEDs are on. The Power Pack can now be disconnected from the Charger. Also, the green LED on the Charger lights up when the Power Pack is fully charged.

LED BEHAVIOUR OF THE POWER PACK DURING CHARGING

During the charging of the Power Pack the LED's will light up as follows:

- Charge level less than 25%: First LED blinks
- Charge level between 25% and 50%:
First LED constantly on, second LED blinks
- Charge level between 50% and 75%:
First and second LED constantly on, third LED blinks
- Charge level between 75% and 97%:
First, second and third LED constantly on, fourth LED blinks
- Charge level more than 97%:
All four LED's on

When not in use, keep the Power Pack and °M Warmer disconnected in order not to discharge the Power Pack.

Power Pack use life: 2 years or 200 charging cycles
The total capacity with the number of charging cycles:

	Power Pack	Power Pack+
- 100 charging cycles:	97,9 %	91,7 %
- 200 charging cycles:	92,3 %	83,0 %

As a guidance, the following use patterns can be described:

- Use once per week: 2-year use life is reached before the 200 charging cycles
- Use twice per week: 200 charging cycles coincide with the 2-year use life
- Use once per day: 200 charging cycles are reached after 6 months

Based on the anticipated use pattern, please label the Power Pack with end-of-life date upon taking the Power Pack into service.

When end-of-life is reached, the capacity of the Power Pack should be tested regularly (e.g., once per month) using the following procedure:

- Fully charge the Power Pack
- Connect the Power Pack to a functioning warmer
- Pass cold fluid (5°C) through the warmer at reasonable flow rate of e.g. 25-100 ml/min (the green LED must stay solid) and measure how much fluid can be warmed before the Power Pack is depleted (all 4 LED's on the Power Pack and the green LED on the warmer shuts off)

8 USE OF THE °M WARMER SYSTEM

- ⚠ Do not use near flammable anaesthetics.
- ⚠ Do not use in oxygen rich environments.

A.

Check that the Power Pack is fully charged by pressing the button on the front of the Power Pack.

If all 4 green LEDs are lit the Power Pack is fully charged and ready for use. If 3 LEDs or less are lit the usage time will be shorter, and it is recommended to charge the Power Pack completely before use. Operating temperature range when discharging the Power Pack is 0°C - 40°C

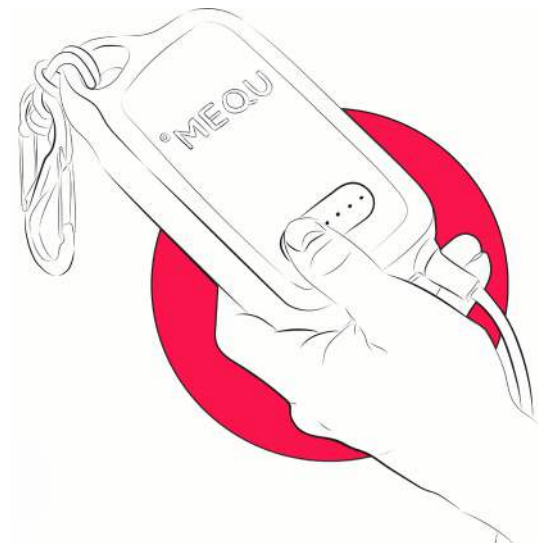

LED BEHAVIOUR OF THE POWER PACK DURING STORAGE

When not in use (i.e. not connected to either charger or °M Warmer), the charge level of the Power Pack can be checked by pressing the button on the display of the Power Pack.

One or more of the green LEDs will light up for 10 seconds, then turn off. If Power Pack is empty no diodes will turn on. When the Power Pack is connected to the °M Warmer, the LED display will be on.

CHARGE LEVEL OF POWER PACK

The Power Pack LED display indicates the following charge level:

- Charge level less than 7%: First LED blinks
- Charge level 7-25%: First LED constantly on
- Charge level between 26% and 50%:
First and second LED constantly on
- Charge level between 51% and 75%:
First, second and third LED constantly on
- Charge level between 76% and 100%:
All four LED's on

For instructions on charging the Power Pack, see the chapter called 'Charging of the Power Pack'.

B.

Connect an IV-giving set to an IV-fluid bag. Insert an IV/IO needle where the IV access is desired.

C.

Take one °M Warmer and open the packaging. Remove the °M Warmer from the packaging, and remove the tamper proof seal around the luer locks. Disconnect the luer locks.



NOTE:

If you need to close the flow through the °M Warmer, you can use the supplied Pinch Clamp. Please mount the Pinch Clamp on the proximal tubing in order not to risk pulling on the venous catheter / IO needle when closing and opening the Pinch Clamp. If you do not mount the Pinch Clamp immediately, please save the Pinch Clamp for later use, if needed.

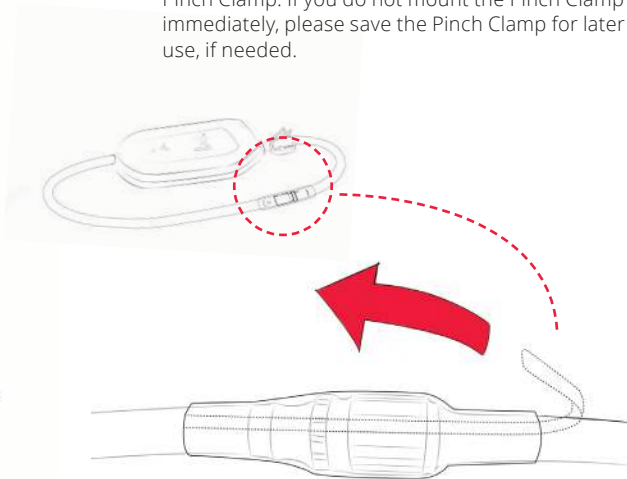

Remove tamper proof seal

- ⚠ Do not use the °M Warmer if not in original packaging.
- ⚠ Do not use the °M Warmer if the tamper proof seal around the luer locks has been opened before time of use. Only the fluid path is sterile, the outside surface of the °M Warmer is not sterile.
- ⚠ Before use, check the expiration date of the °M Warmer device. Do not use if the expiration date has been passed.
- ⚠ Do not use the °M Warmer System outside the stated operating temperature range.
- ⚠ The °M Warmer is single use. Do not reuse due to risk of cross contamination.

D.

Connect input end of °M Warmer – short tube with female luer lock and blue marking – to the IV- fluid administration set.

- ⚠ All IV fluid bags must be vented according to the instructions from the manufacturers of IV fluids before they are connected to the °M Warmer device.



E.

Prime the °M Warmer to remove air bubbles from the tubes and the °M Warmer by letting fluid run through the °M Warmer.

- ⚠ The standard protocols for IV tubes for purging of the infusion set and the °M Warmer must be followed before connecting to a patient.
- ⚠ Care must be taken to ensure that the fluid bag and tubing do not contain air.

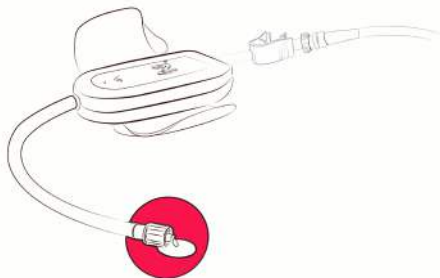

F.

Connect output end of °M Warmer – long tube with male luer lock and red marking – to the IV/IO access.

- ⚠ Where clinically indicated, implement inline filtration between the °M Warmer and the access site, ensuring that the filter is compatible with the intended infusion (i.e. fluid type and flow rate).

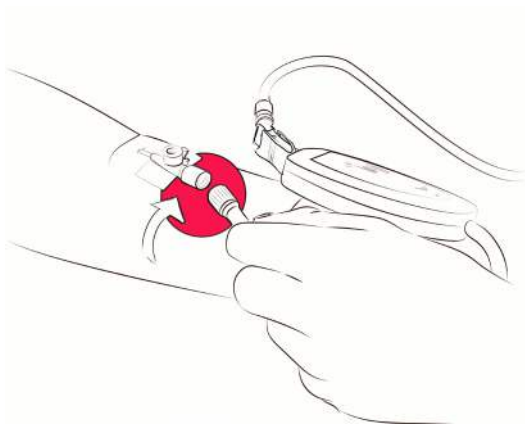

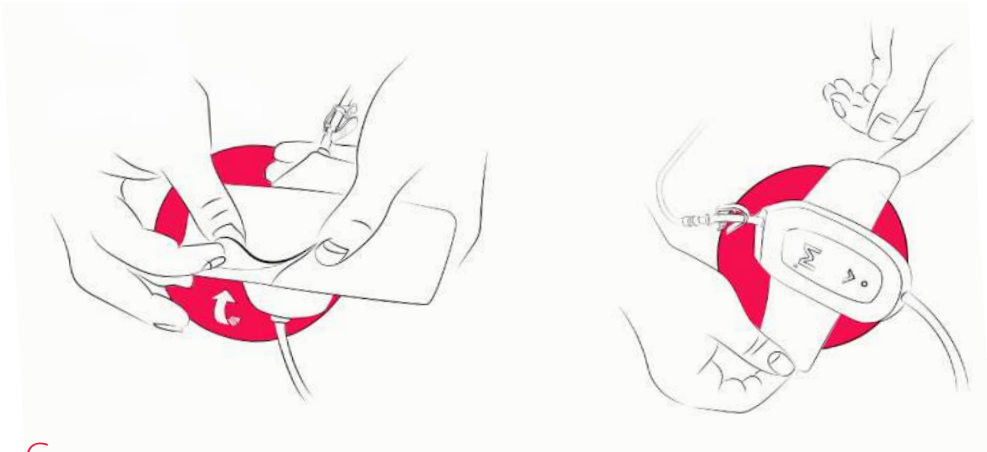
**G.**

Remove the protective film from the adhesive tape on the back of the °M Warmer device and attach the °M Warmer to the patient. Please note, that in some circumstances (e.g. wet skin) the adhesive may not stick properly. In these cases ensure fixation of the °M Warmer using other means of fixation.

- ⚠ Properly attach the °M Warmer to the skin of the patient or in some other way to secure that it does not fall off and pull on the infusion line. The adhesive attached to the °M Warmer may be used, but it may not be sufficient



H.

Connect the Power Pack to °M Warmer and initiate fluid flow.

- ⚠ Do not use if Power Pack shows sign of damage.
- ⚠ Do not connect/disconnect the Power Pack and the °M Warmer close to flammable agents.
- ⚠ Keep the Power Pack away from the patient, as the Power Pack may get hot during use.

As soon as the Power Pack is connected to the °M Warmer, the red LED will blink as part of the °M Warmers self-test procedure, and then the green arrow will blink briefly indicating that the system is heating up.

When °M Warmer has reached set point temperature the arrow will be constant green.

I.

°M WARMER SYSTEM IS ON

The °M Warmer System is now turned on and fluid that flows through the °M Warmer unit will be warmed to 37°C at a flow rate of up to 150 ml per minute.

- ⚠ Keep visible and regularly monitor the status indicators on the °M Warmer and the Power Pack.
- ⚠ A flashing red LED on the °M Warmer device indicates that the heating unit is too warm. Remove the connector of the Power Pack. See 'User Interface and alarms on the °M Warmer system' for further information.
- ⚠ Do not use °M Warmer System in the proximity of an MR scanner.
- ⚠ Do not place the fluid/blood bag below the IV entry point to the patient to ensure that blood/ fluid flow is not reversed.
- ⚠ The °M Warmer device should not be used for more than 72 hours.
- ⚠ The °M Warmer device should only be used with °MEQU's Power Pack or °M Station and not with other power sources.



J.

CHANGE THE FLUID BAG

If the fluid bag runs empty, there may be a need to change to a new fluid bag. To do this, follow this procedure:

- Stop the flow by closing the pinch clamp on the tubing
- Change the fluid bag using standard procedures for changing of fluid bags during IV procedures
- Open the pinch clamp to start the flow again

K.

CHANGE POWER PACK

If the Power Pack is completely discharged or too warm, and if there is another charged Power Pack present, you can change Power Pack in the following way:

- Disconnect the Power Pack from the °M Warmer by removing the Power Pack connector out of °M Warmer
- Connect the fully charged Power Pack to the °M Warmer

9 END THE USE OF THE °M WARMER SYSTEM

- End the flow by closing the pinch clamp on the tube on °M Warmer.
- Disconnect the Power Pack from the °M Warmer.
- Disconnect the °M Warmer from the patient and the IV-giving set. Drain any remaining liquid from the °M Warmer into a container
- Remove the °M Warmer from the patient and dispose the °M Warmer device in accordance with accepted medical practice and applicable regulations.
- Clean the Power Pack. For instructions on cleaning the Power Pack see 'Maintenance and cleaning'.
- Recharge the Power Pack. For instructions on charging the Power Pack, see 'Charging of the Power Pack'

10 USER INTERFACE AND ALARMS ON THE °M WARMER SYSTEM

USER INTERFACE ON THE °M WARMER DEVICE:

- Connection for the IV-giving set: The °M Warmer device has two tubes, each with a luer lock: The short tube with the female luer lock and blue marking is connected to the infusion set, and the long tube with the male luer lock and red marking is connected to IV/IO access. An extension tube should not be connected between the °M Warmer device and IV/IO access since at low ambient temperatures there will be a risk of temperature drop of the liquid prior to the infusion into the patient.
- Connection to the Power Pack: Next to the short tube, the connector from the Power Pack is plugged in.
- Fixing tape: Affixed on the back of the °M Warmer device is a piece of adhesive. This adhesive can be used for attaching the °M Warmer device to the patient. Please note, that in some circumstances (e.g. wet skin) the adhesive may not stick properly. In these cases ensure fixation of the °M Warmer using other means of fixation.

- Green LED as indication of normal operation: The front of the °M Warmer device has a green LED shaped like an arrow. The arrow indicates the direction of the fluid. When the connector from a charged Power Pack is inserted, the green arrow begins to flash. This means that the system is plugged in and is starting to warm up. The green arrow on the °M Warmer unit is constantly lit when temperature of 36°C is reached.

ALARM ON THE °M WARMER DEVICE:

- Red LED as a warning of too warm °M Warmer unit: A flashing red LED on the °M Warmer device indicates that the internal safety circuit has been triggered due to overtemperature. Active fluid heating has been stopped.

A flashing red LED on the °M Warmer device when fluid or blood with a temperature at the entrance of the °M Warmer unit below 37°C is infused, indicates that the °M Warmer device is defective and must be replaced.

Note! If the red LED flashes when no fluid or blood is being infused, it may be a result of the °M Warmer unit having been stored at a temperature above 37°C. This can be tested by passing fluid or blood at a temperature below 37°C through the °M Warmer – if the red LED then stops flashing, and the green LED illuminates, the system is functioning correctly and you can proceed with the infusion.

Note! The red LED flashes briefly when the Power Pack is connected to the °M Warmer as part of the °M Warmer self-test procedure.

See 'System Error and Service'.

USER INTERFACE ON THE POWER PACK

- Connector for the °M Warmer: The connector at the end of the cable on the Power Pack connects to the °M Warmer device.
- LEDs and button to display the battery status: At the front of the Power Pack there are 4 green LEDs and a button to check the battery status. Pressing the button illuminates one or more of the 4 LEDs for 10 seconds. The number of LED's indicates the charge level. If no indicator lights up the battery is completely discharged. For further explanation of how to read the charge level, please see 'Charging the Power Pack'.

USER INTERFACE ON THE CHARGER:

- Power plug for connecting the Charger to mains.
- Connector for the Power Pack: The connector at the end of the cable on the Charger connects to the plug on the end of the Power Pack.

11 MAINTENANCE AND CLEANING

THE °M WARMER

The °M Warmer is a single patient use device. The °M Warmer can be used on the patient for up to 72 hours. The same device must not be reused or reattached to other patients. After use, the device must be disposed - see section 'Disposal'.

THE POWER PACK

When the Power Pack has been in use, it must be cleaned or disinfected, if necessary.

CLEANING AGENTS

Cleaning level	Purpose	Use
Cleaning	Remove clutter, dust, crumbs, dirt, and other detritus	Mild detergent with a twisted lint-free cloth
Chemical disinfection	Destroy germs on contact by eradicating them where they live and inhibiting their spread at the source	Use disinfectants that are medical device approved, such as: perfume-free, alcoholic, aldehyde-free disinfection wipes for fast-acting disinfection of alcohol-resistant surfaces of medical devices

PROCEDURE

- Remove the carabiner, if necessary.
- Clean the connector, cable and Power Pack on all surfaces using mild detergent with a twisted lint-free cloth on all surfaces (cleaning) or use disinfectants that are medical device approved (chemical disinfection).
- Dry off the Power Pack thoroughly after cleaning/disinfection before using it again.
- Do not submerge, sterilize or autoclave the Power Pack.

12 DISPOSAL

THE °M WARMER

 The °M Warmer device may cause a potential biological risk during or after use. Handle and dispose in accordance with accepted medical practice and applicable regulations.

The °M Warmer unit is electrical and electronic equipment (as per EU directive 2012/19/EU on Waste Electrical and Electronic Equipment) and should therefore not be disposed with regular household waste. Take the product to the nearest recycling collection facility. Also, single patient use products may pose a potential biological risk during or after use. Handle and dispose it in accordance with accepted medical practice and applicable regulations.

THE POWER PACK

- The Power Pack is electrical and electronic equipment (as per EU directive 2012/19/EU on Waste Electrical and Electronic Equipment) and should therefore not be disposed with regular household waste. Take the product to the nearest recycling collection facility.

13 OPERATING TEMPERATURE RANGE

- Operating temperature range when charging the Power Pack is: 10°C - 40°C
- Operating temperature range when discharging the Power Pack is: 0°C - 40°C
- ⚠ If °M Warmer has been stored at less than -5°C connect the Power Pack before connecting °M Warmer to the IV-giving set. When arrow on the °M Warmer is green, IV-fluid may be added.
- If stored at temperatures above 43°C, the first safety circuit will be activated, meaning red LED will blink when connected to Power Pack. If temperature is over 43,7°C the second safety circuit will be activated and shut down for all power. Cool down the system to below 43°C before use.
- ⚠ When using the system at high ambient temperatures, with a high flow rate and for prolonged time, the Power Pack may periodically shut down in order to prevent overheating of the Power Pack.
- If Power Pack becomes too warm, the green arrow indicator on the °M Warmer is off, change to another Power Pack and cool down the warm Power Pack.

14 SAFETY INFORMATION

- The °M Warmer System must only be used for its original purpose, i.e. to warm blood, blood products and infusion fluids prior to intravenous administration to help prevent hypothermia.
- The device must not be dismantled or tentatively repaired by any other person than the manufacturer.

For Cautions regarding the Charger – see the separate Charger manual

- ⚠ Before the °M Warmer System is used, the user manual for the °M Warmer System and the Charger should be thoroughly read.
- ⚠ Only use the designated Charger supplied with the °M Warmer System for charging the Power Pack.
- ⚠ Do not use the °M Warmer System outside the stated operating temperature range.
- ⚠ Do not use the °M Warmer if not in original packaging.
- ⚠ Do not use the °M Warmer if the tamper proof seal around the luer locks has been opened before time of use.

- ⚠ Do not use if Power Pack shows sign of damage.
- ⚠ Do not use °M Warmer System in proximity of an MR scanner.
- ⚠ Properly attach the °M Warmer to the skin of the patient or in some other way secure that it does not fall down and pull on the infusion line. The adhesive attached to the °M Warmer may be used, but it may not be sufficient.
- ⚠ All IV fluid bags must be vented according to the instructions from the manufacturers of IV fluids before they are connected to the °M Warmer device.
- ⚠ The standard protocols for IV tubes for purging of the infusion set and the °M Warmer must be followed before connecting to a patient.
- ⚠ The use of inline air and particulate filters is not contraindicated for the °M Warmer, when deemed appropriate by the treating clinician's judgement and in accordance with local clinical guidelines and practices, and with filter manufacturer's instructions for use.
- ⚠ Where clinically indicated, implement inline filtration between the °M Warmer and the access site, ensuring that the filter is compatible with the intended infusion (i.e. fluid type and flow rate).

- ⚠ If °M Warmer has been stored at less than -5°C connect the Power Pack before connecting °M Warmer to the IV-giving set. When arrow is green IV-fluid may be added.
- ⚠ Do not place the fluid/blood bag below the IV/ IO access point to the patient to ensure that blood/fluid flow is not reversed.
- ⚠ Keep the Power Pack away from the patient, as the Power Pack may get hot during use.
- ⚠ Keep visible and regularly monitor the status indicators on the °M Warmer and the Power Pack.
- ⚠ A flashing RED LED on the °M Warmer device indicates that the heating unit is too warm. Remove the connector of the Power Pack. See 'User Interface and alarms on the °M Warmer system' for further information.
- ⚠ The °M Warmer device may cause a potential biological risk during or after use. Handle and dispose in accordance with accepted medical practice and applicable regulations
- ⚠ Do not use near flammable anaesthetics.
- ⚠ Do not use in oxygen enriched environments.
- ⚠ Do not connect/disconnect the Power Pack and the °M Warmer close to flammable agents.
- ⚠ The °M Warmer device should not be used for more than 72 hours.
- ⚠ Before use, check the expiration date of the °M Warmer device. Do not use if the expiration date has been passed.
- ⚠ The °M Warmer device should only be used with Power Pack or °M Station and not with other power sources.
- ⚠ When using the system at high ambient temperatures, with a high flow rate and for prolonged time, the Power Pack may periodically shut down in order to prevent overheating of the Power Pack.
- ⚠ Follow AABB's 'Guidelines for the Use of Blood Warming Devices', which warns against heating when administering platelets, cryoprecipitate, or granulocytic suspensions.
- ⚠ Some medications or compositions may be sensitive to heating. As is the case with all systems for heating liquids and blood, the manufacturer's instructions regarding the medications' heat sensitivity should be carefully read before use.
- ⚠ Do not pass medications through the °M Warmer System. If needed, infuse the medications after the °M Warmer.
- ⚠ Do not use the °M Warmer with infusions fluids with a pH lower than 3 or higher than 8.
- ⚠ The °M Warmer is single use. Do not reuse due to risk of cross contamination.

15 SYSTEM ERROR AND SERVICE

FAULTY POWER PACK:

In case the Power Pack is not showing any illuminated LEDs after it has been plugged into a functional Charger, connected to an active power outlet, for more than 2.5 hours, the Power Pack is defective. If the Power Pack is within the warranty period, it can be exchanged at a licensed °MEQU distributor.

DEFECTIVE °M WARMER DEVICE















The °M Warmer device is not working if the green LED does not illuminate within approx. 10 seconds of a fully charged Power Pack being connected. Replace the °M Warmer device with a new °M Warmer device. A flashing or illuminated red LED on the °M Warmer when fluid or blood with an initial temperature below 37°C is passed through the °M Warmer, indicates that the °M Warmer device is defective and must be replaced.

















The following table summarises the behaviour of the LEDs and actions to take.

GREEN LED	RED LED	STATUS	CAUSE	ACTION
off	off	No heating	No power or °M Warmer is faulty	Check battery state and cable connection between Power Pack and °M Warmer. If there are no issues, replace the °M Warmer
flashing	off	Warming up	$T < 36^{\circ}\text{C}$	Wait for target temperature to be reached
on	off	Temperature good	$36^{\circ}\text{C} \leq T \leq 43^{\circ}\text{C}$	Monitor infusion and °M Warmer LEDs
off	flashing	No heating	°M Warmer has been stored at elevated temperature or °M Warmer is faulty	If state persists despite cold fluid or blood being passed through the °M Warmer, replace the °M Warmer
	on	No heating	°M Warmer is faulty	Replace the °M Warmer

16 SYMBOLS

The following symbols can be found on products or accessories that constitute the °M Warmer System.
For symbols on the Charger – see the separate Charger manual.

SYMBOL	DESCRIPTION	SYMBOL	DESCRIPTION
	Medical Device		The ingress protection level against solid foreign objects and water.
	Refer to Instructions for Use		Manufacturer
	Class II Equipment		Temperature limitation
	Pressure		Do not use if packaging is damaged
	Caution, consult accompanying documents		For single use only. Do not reuse.
	Use by yyyy-mm-dd or yyyy-mm		Serial number
	Catalog number		Dispose product according to WEEE Directive

SYMBOL	DESCRIPTION	SYMBOL	DESCRIPTION
	Do not resterilize		Keep away from sunlight
	Date of manufacturing		GS1 datamatrix
	Keep away from rain		Humidity
	Non-pyrogenic fluid path		Type BF equipment
	Defibrillation proof type BF equipment.		MR Unsafe, items should not enter the MRI scanner room. Patients with MR Unsafe devices should not be scanned
	Batch code		Barcode
	Sterilized fluid path using radiation		The product confirms to European MDD 93/42/EEC /MDR EU 2017/745. If the mark is accompanied by a number, conformity is verified by the indicated notified body.
	Recycle		CAUTION: Federal law (USA) restricts this device to sale by or on the order of a physician.

17 TECHNICAL SPECIFICATIONS

DIMENSIONS	
Size	Power Pack / Power Pack+: 9cm (W); 18cm (L); 3.5cm (H); cable length 120cm °M Warmer: 5cm(W); 10cm(L); 2cm(H) Charger: 7.5cm (W); 11.7cm(L); 4.4cm (H); cable length 168cm
Weight	Power Pack: 650g, Power Pack+: 710g, °M Warmer: 110g, Charger: 250g
POWER	
Battery Nominal Voltage	21,6V
ENVIRONMENTAL	
Operating Temperature Power Pack / Power Pack+ & °M Warmer - Fluid warming mode:	0°C - +40°C
Operating Temperature Power Pack / Power Pack+ & Charger - Charging mode:	10°C - +40°C
Relative Humidity RH	15 - 95%
Pressure	60 - 106kPa
Storage Temperature	-20 - +50°C
Shock and Vibration	EN 1789:2007 + A2 Sec. 6.4
Electrical Compliance	EN 60601-1

OPERATING PARAMETERS		
Max flow Rate (input temp. of 5°C, output temp. of min. 36°C)	150 ml/min	
Max fluid warming volume on one fully charged battery (output temperature of min. 36°C)	Input temperature 5°C: – Power Pack: 1,5L – Power Pack+: 2L	Input temperature 21°C: – Power Pack: 3L – Power Pack+: 4L
Output target Temperature Range	39°C ±3°C	
Prime Volume	3.5 ml with valves and tubing	
Maximum inlet pressure	300 mmHg	
LED (On Battery Heating Unit)	Green: Solid – °M Warmer is within target temperature Green: Flashing – °M Warmer is below target temperature RED: Flashing – Over Heat Alarm	
SAFETY AND MONITORING		
Heater Temperature Monitoring	Heater power shuts off before fluid temperature exceeds ASTM F2172 blood warmer standard limits.	
Independent Safety Circuit	Shuts off power before fluid temperature exceeds ASTM F2172 blood warmer standard limits.	
Alarm Condition	NO HEATING/OVER TEMPERATURE (red flashing diode) NO HEATING/FAULT (red diode illuminated or no LEDs on)	

°M WARMER DEVICE										
Single patient use device	Sterile fluid path, Non-Pyrogenic Fluid Path, Single Use Only									
Sterilization method	E-beam									
RECHARGEABLE POWER PACK										
Standard recharge time	Power Pack: 2.5 hours Power Pack+: 3 hours									
Standard charger input voltage	100 - 240VAC									
Power Pack use life	2 years or 200 charging cycles The total capacity with the number of charge cycles: <table border="0" style="margin-left: 40px;"> <tr> <td></td> <td style="text-align: center;">Power Pack</td> <td style="text-align: center;">Power Pack+</td> </tr> <tr> <td>- 100 charge cycles:</td> <td style="text-align: center;">97,9 %</td> <td style="text-align: center;">91,7 %</td> </tr> <tr> <td>- 200 charge cycles:</td> <td style="text-align: center;">92,3 %</td> <td style="text-align: center;">83,0 %</td> </tr> </table>		Power Pack	Power Pack+	- 100 charge cycles:	97,9 %	91,7 %	- 200 charge cycles:	92,3 %	83,0 %
	Power Pack	Power Pack+								
- 100 charge cycles:	97,9 %	91,7 %								
- 200 charge cycles:	92,3 %	83,0 %								
Electrical compliance	EN 60601-1									
CHARGER										
Charger use life	2 years									
CLASSIFICATION										
Degree of Protection Against Harmful Ingress of Subjects/Water: IP54	Ingress of dust is not entirely prevented, but it must not enter in sufficient quantity to interfere with the satisfactory operation of the equipment; complete protection against contact. Water splashing against the enclosure from any direction shall have no harmful effect									
Mode of operation	Continuous									

18 ELECTROMAGNETIC COMPATIBILITY

In Active heating and in Charging modes the °M Warmer System has been tested for Electromagnetic Compatibility according to EN 60601-1-2:2015 for use in the Professional healthcare facility and in the Home healthcare environments.

Additionally the °M Warmer System in Active heating mode has been tested for Electromagnetic Compatibility according to RTCA DO-160G, Section 20 and 21 for use in an Air ambulance environment.

In the following tables the compliance levels are specified.

°M Warmer System EMC compatibility levels according to EN 60601-1-2:2015.

GUIDANCE AND MANUFACTURER'S DECLARATION – ELECTROMAGNETIC EMISSIONS		
The °M Warmer System is intended for use in the electromagnetic environment specified below. The user of the °M Warmer System should assure that it is used in such an environment.		
EMISSION TEST	COMPLIANCE	ELECTROMAGNETIC ENVIRONMENT - GUIDANCE
RF emissions CISPR 11	Group 1	The °M Warmer System uses RF energy only for its internal function. Therefore, its RF emissions are very low and are not likely to cause any interference in nearby electronic equipment. The °M Warmer System is suitable for use in all establishments including domestic establishments and those directly connected to the public low-voltage power supply network that supplies buildings used for domestic purposes.
RF emissions CISPR 11	Class B	
Harmonic emissions IEC 61000-3-2	Not applicable	
Voltage fluctuations / flicker emissions IEC 61000-3-3	Complies	

GUIDANCE AND MANUFACTURER'S DECLARATION - ELECTROMAGNETIC IMMUNITY

The °M Warmer System is intended for use in the electromagnetic environment specified below. The customer or the user of the °M Warmer System should assure that it is used in such an environment.

IMMUNITY TEST	IEC 60601 TEST LEVEL	COMPLIANCE LEVEL	ELECTROMAGNETIC ENVIRONMENT - GUIDANCE
Electrostatic discharge (ESD) IEC 61000-4-2	±8 kV contact ±2 kV, ±4 kV, ±8 kV, ±15 kV air	±8 kV contact ±2 kV, ±4 kV, ±8 kV, ±15 kV air	The °M Warmer System can be used in a dry environment.
Electrical fast transients/bursts IEC 61000-4-4	±2 kV for power supply lines ±2 kV for input/output lines	±2 kV for Charger power supply line Not applicable	Mains power quality should be that of a typical Professional healthcare facility or Home healthcare environment.
Surges IEC 61000-4-5	±0.5 kV, ±1 kV Line-to-line ±0.5 kV, ±1 kV, ±2 kV Line-to-ground	±0.5 kV, ±1 kV Line-to-line ±0.5 kV, ±1 kV, ±2 kV Line-to-ground	

IMMUNITY TEST	IEC 60601 TEST LEVEL	COMPLIANCE LEVEL	ELECTROMAGNETIC ENVIRONMENT - GUIDANCE
Voltage dips IEC 61000-4-11	0 % UT; 0.5 cycle at 0°, 45°, 90°, 135°, 180°, 225°, 215° 0 % UT; 1 cycle at 0°	0 % UT; 0.5 cycle at 0°, 45°, 90°, 135°, 180°, 225°, 215° 0 % UT; 1 cycle at 0°	Mains power quality should be that of a typical Professional healthcare facility or Home healthcare environment.
	70 % UT; 25/30 cycles at 0°	70 % UT; 25/30 cycles at 0°	
Voltage interruptions IEC 61000-4-11	0 % UT; 250/300 cycles	0 % UT; 250/300 cycles	
Power frequency (50/60 Hz) magnetic field IEC 61000-4-8	30 A/m	30 A/m	Power frequency magnetic fields should be at levels characteristic of a typical Professional healthcare facility or Home healthcare environment.
NOTE UT is the a.c. mains voltage prior to application of the test level.			

GUIDANCE AND MANUFACTURER'S DECLARATION – ELECTROMAGNETIC IMMUNITY			
The °M Warmer System is intended for use in the electromagnetic environment specified below. The customer or the user of the °M Warmer System should assure that it is used in such an environment.			
IMMUNITY TEST	IEC 60601 TEST LEVEL	COMPLIANCE LEVEL	ELECTROMAGNETIC ENVIRONMENT - GUIDANCE
Conducted RF IEC 61000-4-6	3 Vrms 150 kHz - 80 MHz Outside ISM bands	6 Vrms 150 kHz - 80 MHz	<p>Portable and mobile RF communications equipment should be used no closer to any part of the °M Warmer System, than the recommended separation distance calculated from the equation applicable to the frequency of the transmitter.</p> <p>Recommended separation distance $d = 0.58 \times \sqrt{P}$, 150 kHz to 80 MHz</p> <p>$d = 1.17 \times \sqrt{P}$, 80 MHz to 800 MHz $d = 2.3 \times \sqrt{P}$, 800 MHz to 2.5 GHz</p> <p>Where P is the output power rating of the transmitter in watts (W) according to the transmitter manufacturer and d is the recommended separation distance in meters (m). Field strengths from fixed RF transmitters, as determined by an electromagnetic site survey, ^A should be less than the compliance level in each frequency range. ^B</p>
	6 Vrms in ISM and amateur radio bands between 150 kHz and 80 MHz		
Radiated RF IEC 61000-4-3	3 V/m 80 MHz to 2.5 GHz	3 V/m	<p>Interference may occur in the vicinity of equipment marked with the following symbol:</p>

NOTE 1 At 80 MHz and 800 MHz, the higher frequency range applies.

NOTE 2 These guidelines may not apply in all situations. Electromagnetic propagation is affected by absorption and reflection from structures, objects and people.

^A Field strengths from fixed transmitters, such as base stations for radio (cellular/cordless) telephones and land mobile radios, amateur radio, AM and FM radio broadcast and TV broadcast cannot be predicted theoretically with accuracy. To assess the electromagnetic environment due to fixed transmitters, an electromagnetic site survey should be considered. If the measured field strength in the location in which the °M Warmer System is used exceeds the applicable RF compliance level above, the °M Warmer System should be observed to verify normal operation. If abnormal performance is observed, additional measures may be necessary, such as reorienting or relocating the °M Warmer System.

^B Over the frequency range 150 kHz to 80 MHz, field strengths should be less than 6 V/m.

RECOMMENDED SEPARATION DISTANCES BETWEEN PORTABLE AND MOBILE RF COMMUNICATIONS EQUIPMENT AND THE °M WARMER SYSTEM

The °M Warmer System is intended for use in the electromagnetic environment in which radiated RF disturbances are controlled. The customer or the user of the °M Warmer System can help prevent electromagnetic interference by maintaining a minimum distance between portable and mobile RF communications equipment (transmitters) and the °M Warmer System as recommended below, according to the maximum output power of the communications equipment.

RATED MAXIMUM OUTPUT POWER OF TRANSMITTER (W)	Separation distance according to frequency of transmitter (m)		
	150 kHz to 80 MHz $d = 0.58 \times$	80 MHz to 800 MHz $d = 1.17 \times$	800 MHz to 2.5 GHz $d = 2.3 \times$
0.01	0.058	0.12	0.23
0.1	0.18	0.37	0.74
1	0.58	1.17	2.3
10	1.84	3.7	7.4
100	5.8	11.7	23

For transmitters rated at maximum output power not listed above, the recommended separation distance d in meter (m) can be estimated using the equation applicable to the frequency of the transmitter, where P is the maximum output power rating of the transmitter in watts (W) according to the transmitter manufacturer.

NOTE 1: At 80 MHz and 800 MHz, the separation distance for the higher frequency range applies.

NOTE 2: These guidelines may not apply in all situations. Electromagnetic propagation is affected by absorption and reflection from structures, objects and people.

°M Warmer System EMC compatibility levels for Airborne Equipment according to RTCA DO-160G Section 20 and 21.

RF SUSCEPTIBILITY ACCORDING TO RTCA DO-160G – SECTION 20

The °M Warmer System is intended for use in the electromagnetic environment specified below. The customer or the user of the °M Warmer System should assure that it is used in such an environment.

CLAUSE 20.4 CONDUCTED SUSCEPTIBILITY TEST

Frequency [MHz]	Compliance category	Compliance test level [mA]
0.01 – 0.1	Y	6 – 60
0.1 – 0.5	Y	60 – 300
0.5 – 100	Y	300
100 – 400	W	80 – 32

CLAUSE 20.5 RADIATED SUSCEPTIBILITY TEST

Frequency [MHz]	Compliance category	Compliance test level [V/m]
100 – 200	R	40
200 – 1000	W	100
1000 – 18000	Y	200

EMISSION OF RF ENERGY ACCORDING TO RTCA DO-160G – SECTION 21		
The °M Warmer System is intended for use in the electromagnetic environment specified below. The customer or the user of the °M Warmer System should assure that it is used in such an environment.		
Clause 21.4 Conducted RF Emissions		
Frequency [MHz]	Compliance category	Compliance test limits Peak [dBµA]
0.15 – 2	M	53 – 20
2 – 30	M	20
30 – 152	M	30
Clause 21.5 Radiated RF Emissions		
Frequency [MHz]	Compliance category	Compliance test limits Peak [dBµV/m]
100 – 108	M	44.612 – 45.146
108 – 152	M	35 – 67.5
152 – 960	M	47.515 – 60.294
960 – 1215	M	50.3 – 52
1215 – 1525	M	61.927 – 63.503
1525 – 1680	M	53.5 – 54
1680 – 6000	M	64.174 – 73

19 ORDERING INFORMATION

Order number / Description

- *MWS001*
°M Warmer Starter Kit
(1 Power Pack, 1 Charger, 5 °M Warmers)
- *MWS002*
°M Warmer Starter Kit+
(1 Power Pack+, 1 Charger, 5 °M Warmers)
- *MWS101*
1 Power Pack
- *MWS102*
1 Power Pack+
- *MWS201*
°M Warmer 5 pcs
(Box with 5 °M Warmers)
- *MWS301*
1 Charger for charging Power Pack
- *MWS401*
°M Station
- *MWS402*
°M Station w. Ground

For accessories, available replacement and spare parts, please contact your local °MEQU distributor.

Designed and manufactured in Denmark

°MEQU A/S
Ole Maaløes Vej 3
2200 København N
Denmark
www.mequ.dk

MQ1-S004-9.0
2022-12-05